

The drawing contains safety and other information which is the property of Swivel-Head Air Data Boom, Inc. and is to be used only for the purpose intended. No part of this drawing may be reproduced or transmitted in any form or by any means electronic or mechanical, including photocopying, recording, or by any information storage and retrieval system, without the written permission of Swivel-Head Air Data Boom, Inc.

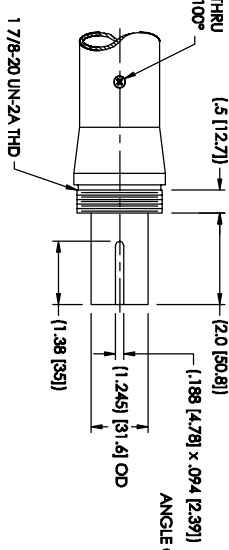

VIEW B-B

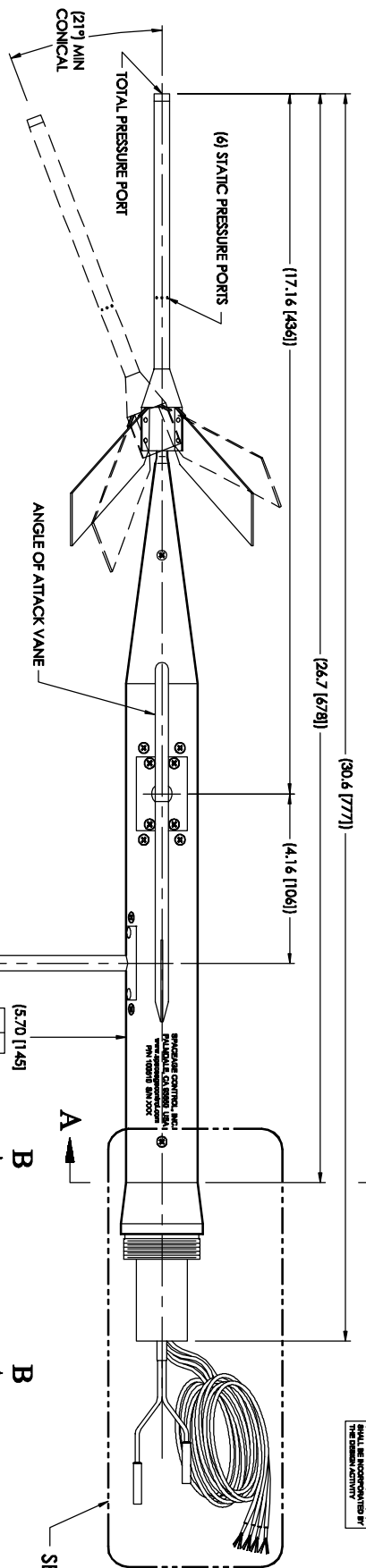
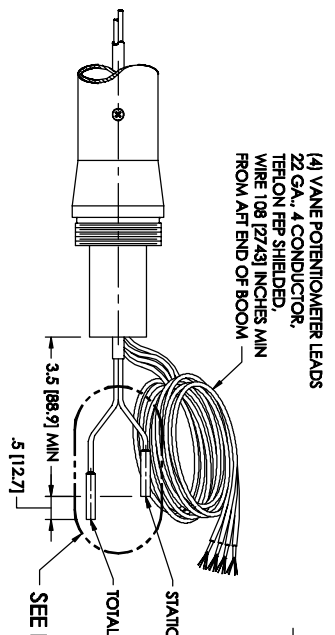
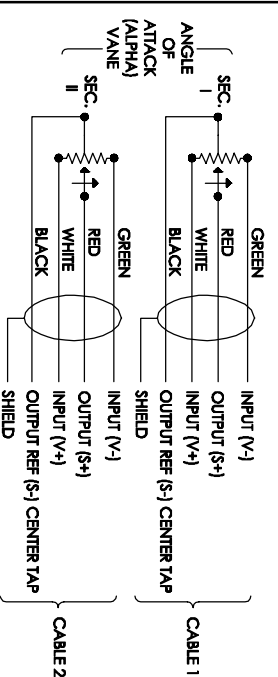

DETAIL C

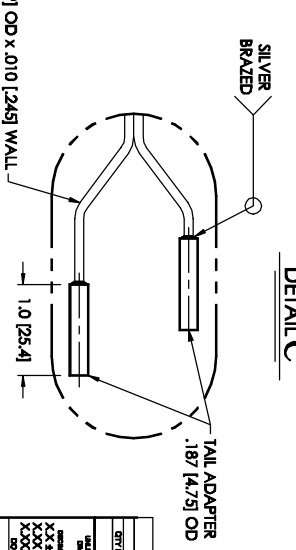
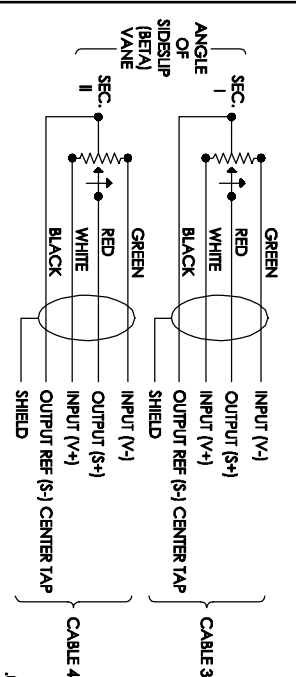

DETAIL D

APPROVED MASTER DWG FILE
DO NOT MODIFY WITHOUT PRIOR APPROVAL
DATE: 6-18-02 DWG

SECTION A-A

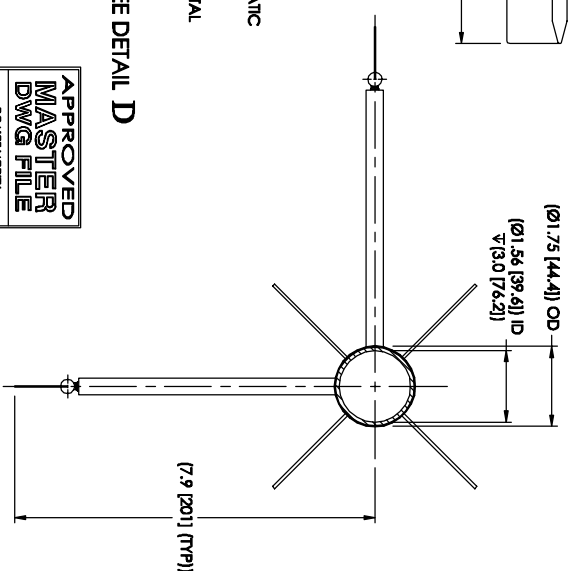

REV.	DESCRIPTION	DATE	APPROVED
D	PER ECO #0898	2-27-02	S/SIMPSON
E	PER ECO #0937	6-17-02	S/SIMPSON

DATE/REVISIONS CHANGED BY SHALL BE INDICATED BY THE DRAWING ACTIVITY

REV.	DESCRIPTION	DATE	APPROVED
1	100510	11-13-97	
2	SWIVEL-HEAD AIR DATA BOOM	11-13-97	

SWIVEL-HEAD AIR DATA BOOM

SpacAge Control, Inc.

DATE: 11-13-97

APPROVAL: S.W. COBB

DESIGNER: S.W. COBB

CHECKED: S.W. COBB

DRAWN: S.W. COBB

SCALE: 1:1

FIG. C 34851

REV. E